

# LCN 4310ME SERIES

FEATURES

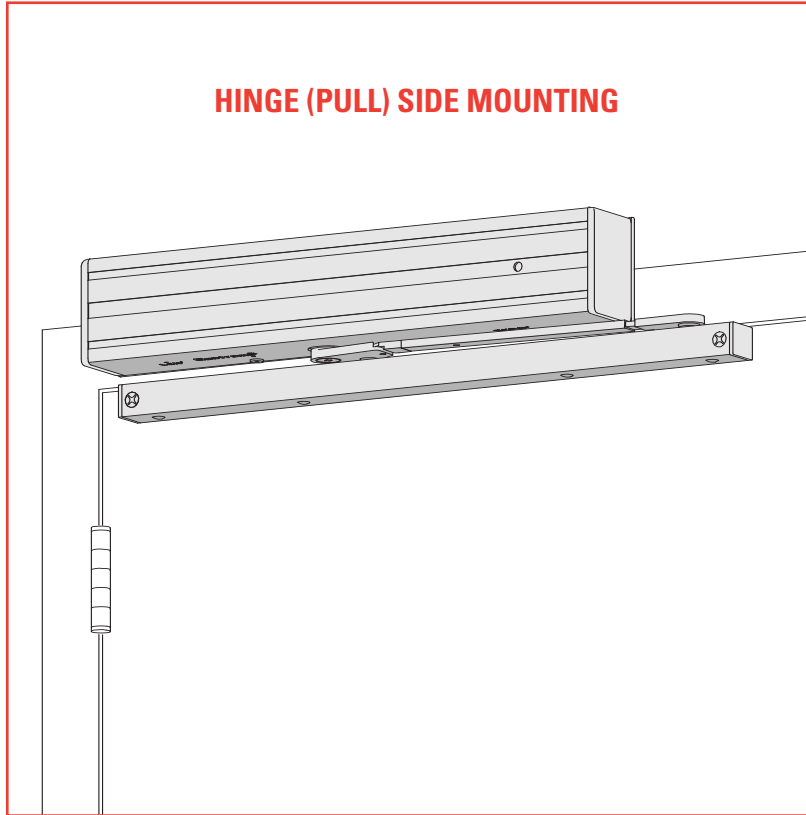

*The 4310ME SENTRONIC® is a heavy duty, electrically controlled closer/holder designed to provide infinitely adjustable hold-open for fire and smoke barrier doors. Door is held open until current interruption releases mechanism and the door closes. Single lever (track) arm closer is specifically designed for interior doors. Choice of finishes, cylinder functions, and installation accessories meet virtually all life safety requirements.*

- ▶ Standard 4310ME series closer shipped with a 24V or 120V cylinder (please specify) on a mounting plate, metal cover, Swing-Free arm, track, track roller, and wood and machine screw pack. See 4310ME Series pages 29 & 30 for options.
- ▶ Sized cylinders for interior doors to 4'0".
- ▶ Functions as full rack and pinion door closer when hold-open is not engaged or current is interrupted with Swing-Free arm engaged.
- ▶ Handed for right or left swinging door.
- ▶ Concealed or exposed electrical connections.
- ▶ Built-in "On/Off" switch controls hold-open function.
- ▶ Swing-Free arm allows door to be moved without door closer resistance.
- ▶ Interfaces with fire alarm systems. Consult factory.
- ▶ Standard or optional custom powder coated finish.
- ▶ Optional plated finish on cover, arm, and fasteners.

*The 4310ME is UL listed for smoke barrier or labeled fire doors. Tested and certified under ANSI Standard A156.15. Conforms to life safety code, NFPA 101. An ME provides only the closer/holder function.*

MOUNTING					FINISH		COVER		CYLINDER			*ARM FUNCTION						
HINGE (PULL) SIDE	TOP JAMB (PUSH)	STOP FACE (PUSH)	CONCEALED (FRAME)	CONCEALED (DOOR)	POWDER COAT	PLATED	PLASTIC	METAL	HANDED	NON-SIZED	SIZED	SINGLE-POINT HOLD-OPEN	MULTI-POINT HOLD-OPEN	BYPASS 80/140	STANDARD (SINGLE)	REGULAR (DOUBLE)	SWING FREE	DOUBLE EGRESS
●	○	○	○	○	●	●	○	●	●	○	○	●	●	○	○	160°	95°	

● Available  
○ Not available

\* Maximum hold-open with standard template. See individual closer series for degrees of opening and hold-open per installation.

# LCN 4310ME SERIES

## MOUNTING DETAILS

### HINGE (PULL) SIDE MOUNTING

Information applies to ME closer.

### MAXIMUM OPENING

Templating allows 180°.

Infinite hold-open points up to 160°.

Optional double egress arm limited to 95°.

### ME ELECTRICAL OPTIONS

These assemblies have a single electrical circuit with a choice of voltages. A separate TRANSFORMER, 4040SE-3210, can be used to reduce line voltage to 24V AC. Circuitry accepts either AC or DC input. 24V holding solenoid (**24**) or 120V holding solenoid (**120**), please specify.

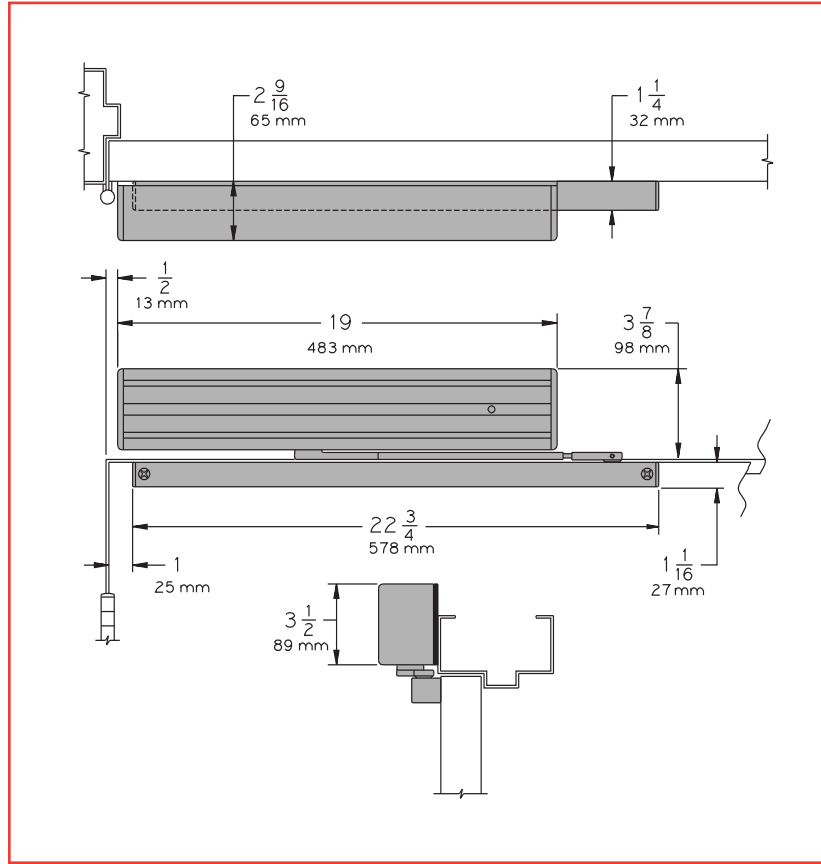

- ▶ **Butt Hinges** should not exceed 4 1/2" (114 mm) in width.
- ▶ **Top Rail** 1 1/16" (27 mm) minimum.
- ▶ **Reveal** should not exceed 1/8" (3 mm) for Swing-Free arm. Should not exceed 2 11/16" (68 mm) for double egress arm.
- ▶ **Head Frame** requires 2" (51 mm) minimum.
- ▶ **Clearance** of 1 1/4" (32 mm) behind door required for installation.
- ▶ **Bypass** (suffix "B80 or B140") eliminates hold-open function up to a specified point of the doors swing. B80 cylinder from 0° to 80°. B140 cylinder from 0° to 140°.
- ▶ **Wiring Diagram**

### Options

- ▶ Hold-open bypass.
- ▶ Double egress arm.
- ▶ 24V or 120 volt input, please specify.

### Special Templates

Customized installation templates or products may be available to solve unusual applications. Contact LCN for assistance.

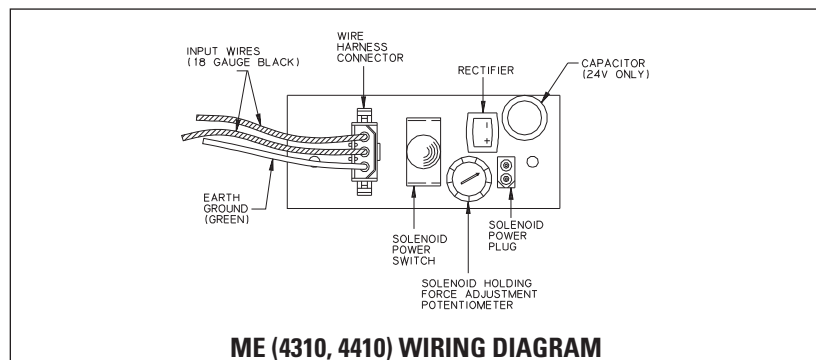

ME (4310, 4410) WIRING DIAGRAM

## CYLINDER

### ME CYLINDER, 4310ME-3971

Standard, handed cast iron cylinder assembly. 24V holding solenoid **(24)** or 120V holding solenoid **(120)**, please specify. For various applications see "Table of Sizes" on 4310ME Series page 31.

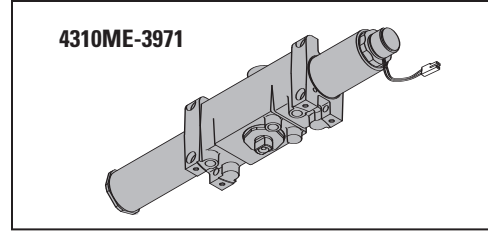

### ME CYLINDER, 4310ME-3071

Standard, handed cylinder and mounting plate assembly. "On/Off" switch assembly controls hold-open function. Circuitry accepts either AC or DC input. 24V holding solenoid **(24)** or 120V holding solenoid **(120)**, please specify. For various applications see "Table of Sizes" on 4310ME Series page 31.

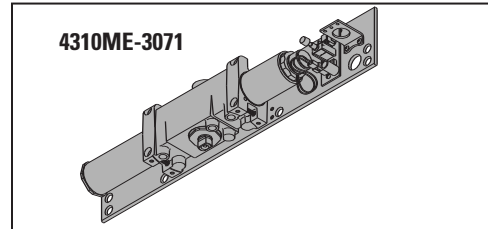

## COVERS

### COVER, 4310ME-72MC

Handed, metal cover.

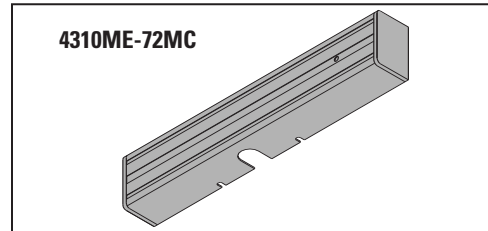

## ARMS

### SWING-FREE ARM, 4310ME-3077SF

Handed arm. After door is placed in hold-open, secondary pivot point allows up to 160° swing without door closer resistance.

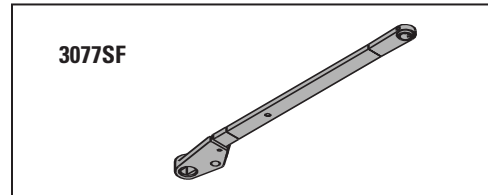

### DOUBLE EGRESS ARM, 4310ME-3077DE

Optional, handed arm for double egress doors and frames. 2 11/16" (68 mm) maximum reveal.

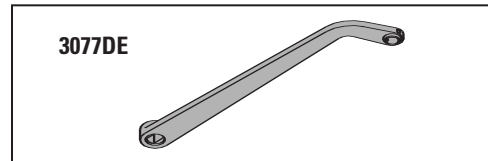

## TRACK

### TRACK, 4310ME-3038

Standard, non-handed track.

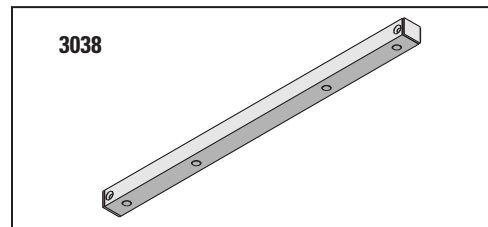

## SWITCH

### SWITCH, 4310ME-3351

"On/Off" switch assembly provides continuous hold-open function. Available as 24V or 120V, please specify.

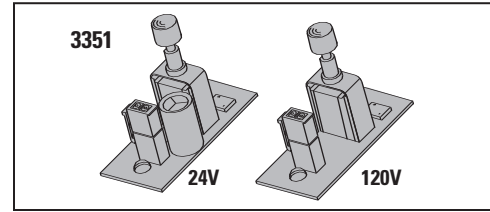

## INSTALLATION ACCESSORIES

### TRACK ROLLER, 4310ME-3034

Quiet, low friction roller assembly.  
Shoulder dimension "X" = 1/8 (3mm).

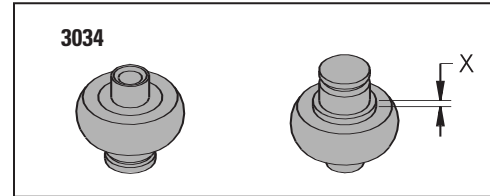

### TRANSFORMER, 4040SE-3210

Reduces line voltage from 120V to 24V AC.  
Mounted on cover for 4" (102 mm) x 4" x 2 1/8" (54mm) junction box (by others).

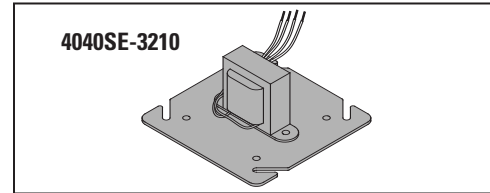

### ME WIRING HARNESS, 4310ME-3354

Three wire harness with 6" (152 mm) leads for field wiring connections.

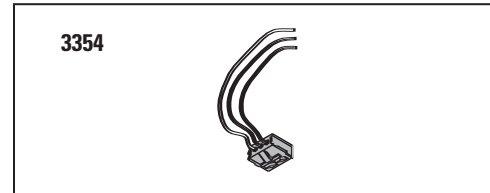

# LCN 4310ME SERIES

**TABLE OF SIZES** Select closer based on width of door.  
Sized 4310ME series cylinders available in size 3 or 4.  
Closing power of all 4310ME Series closers may be increased 15%.

→ Indicates recommended range of door width for closer size.

## INTERIOR DOOR WIDTH

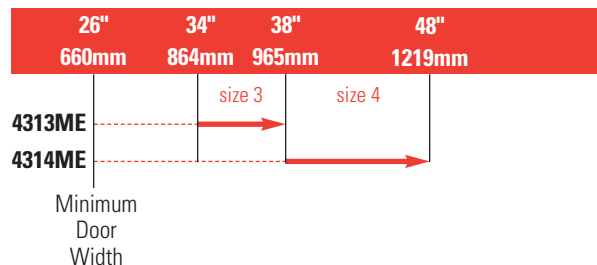

## HOW-TO-ORDER 4310ME SERIES CLOSERS

### 1. SELECT CYLINDER SIZE.

- 4313ME
- 4314ME

### 2. SPECIFY HAND.

- RH
- LH

### 3. VOLTAGE

- 24V AC/DC
- 120V AC/DC

### 4. SPECIFY FINISH.

- Standard Powder Coat \_\_\_\_\_  
Aluminum, Dark Bronze, Tan, Statuary,  
Light Bronze, Black, Brass.

#### Closer will be shipped with:

- STANDARD COVER,
- SWING-FREE (SF) ARM,
- STANDARD TRACK,
- TRACK ROLLER,
- WOOD & MACHINE SCREW PACK,  
unless options listed below are selected.

## CLOSER OPTIONS

### CYLINDER FUNCTION

- Bypass 80° (B80)
- Bypass 140° (B140)

### ARM

- Double Egress (DE)

### FINISHES

- Custom Powder Coat (RAL) \_\_\_\_\_
- Plated Finish, US \_\_\_\_\_

### SCREW PACK

- TB\*, Wood & Machine Screw (TBWMS)
- TORX Machine Screw (TORX)
- TB\* & TORX Machine Screw (TBTRX)

\*Specify door thickness if other than 1 3/4".

### INSTALLATION ACCESSORIES

- Transformer, 4040SE-3210

### SPECIAL TEMPLATE

- ST-\_\_\_\_\_